

# NICHE 90° MARKER LIGHT

*The Niche Light* is an incredibly useful and flexible micro size series of fixtures that serve many desirable applications. Our LED module with CMC cable is the core of this line, with six different trim styles and multiple finishes make this the most versatile fixture line in the market.

Design it into places where discrete lighting is required and where conventional fixtures would be out of place, too bright and intrusive.

The Coastal Source Niche Light family: Small, Beautiful and Effective!

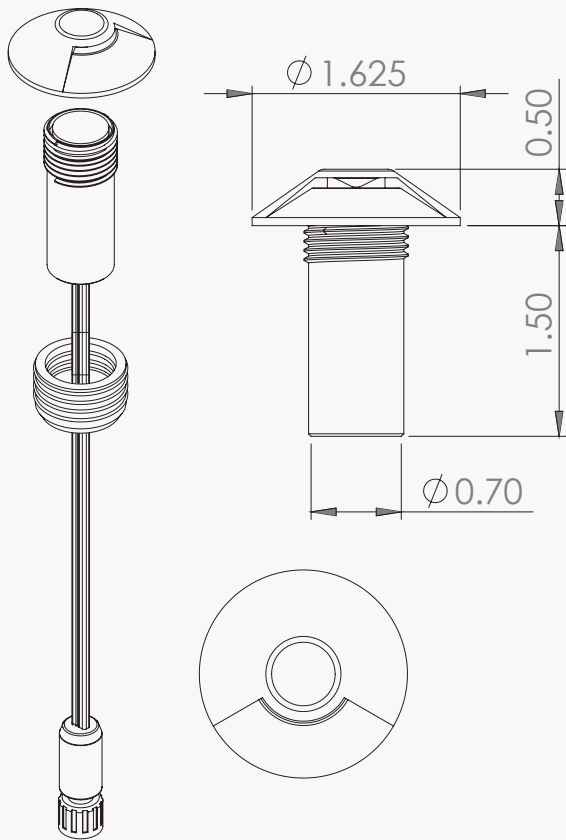

## NICHE 90° MARKER LIGHT SPECIFICATIONS

**Size:** 2.0in (L) x 1.625in ( $\phi$ )

**Weight:** 4.0 oz

**Construction:** Solid Brass

**Voltage:** 10-18V

**Finish:** Vintage, Beaded, White, Nickel, Copper

**Shroud:** 90° Marker with Gasket

**Lamp:** LED Module

**Wattage:** 3 Watts (120lm)

**Color Temperature:** 2700K, 3000K

**Lens (Short Throw Only):** 30° lens (installed), clear & frosted flat lenses also included





**Fixture Connector:** CMC Male Direct Connector

**Wiring:** 18" CMC Pigtail w/18AWG Zipcord (included)

**Warranty:** LED Module (5 Years)

Cable & Brass Parts (Lifetime\*)





# ORDERING INFORMATION

FIXTURE	TYPE	COLOR TEMPERATURE	FINISH
<b>N90M</b> (NICHE LIGHT)	<b>ST</b> (SHORT THROW)	<b>2.7K</b> (2700K)	<b>VB</b> (VINTAGE BRASS) 
	<b>LT</b> (LONG THROW)	<b>3K</b> (3000K)	<b>BR</b> (BEADED BRASS) 
			<b>WT</b> (WHITE) 
			<b>NI</b> (NICKEL) 
			<b>CU</b> (COPPER) 

**N90M** — 
 **ST** — 
 **2.7K** — 
 **VB**

e.g. **N90ST2.7KVB** = Short Throw, 2700K, Vintage Brass Niche 90° Marker Light

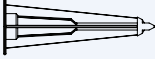
## ACCESSORIES

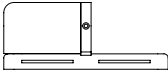
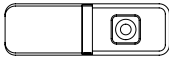
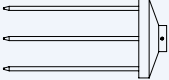
SKU	ITEM		
FM1/2xx	½" Flush Mount		
		½" Flush Mount	¾" Flush Mount
NCH.5-.75ADPT-VB	Niche Light ½" to ¾" Adapter		
RTS8xx RTS12xx	Removable Tip Stakes		
		8" Stake	12" Stake
SMTxx	Solo Tree Mount		
SSTK1/2VB SSTK3/4VB	SpeedStakes™		

\*Lifetime Warranty for certified installations. See terms and conditions of sale for details.