

NICHE ESCUTCHEON LIGHT

The Niche Escutcheon Light is an incredibly useful and flexible micro size series of fixtures that serve many desirable applications. Our LED module with CMC cable is the core of this line, with six different trim styles and multiple finishes make this the most versatile fixture line in the market.

Design it into places where discrete lighting is required and where conventional fixtures would be out of place, too bright and intrusive.

The Coastal Source Niche Light family: Small, Beautiful and Effective!

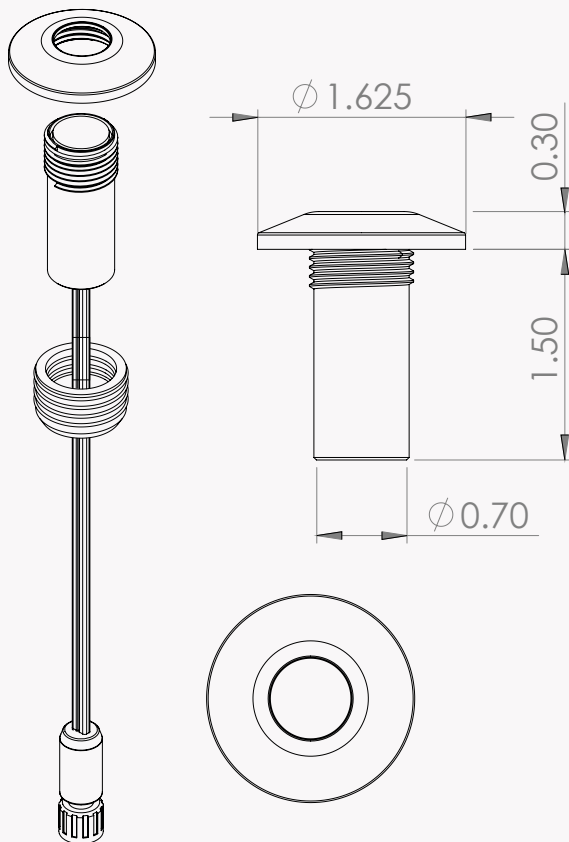

NICHE ESCUTCHEON LIGHT SPECIFICATIONS

Size: 2.0in (L) x 1.625in (ϕ)

Weight: 4.0 oz

Construction: Solid Brass

Voltage: 10-18V

Finish: Vintage Brass & Beaded Brass

Shroud: Escutcheon Shroud with Gasket

Lamp: LED Module

Wattage: 3 Watts (120lm)

Color Temperature: 2700K, 3000K

Lens: 30° lens (installed)

Clear & Frosted flat lenses also included



Fixture Connector: CMC Male Direct Connector

Wiring: 18" CMC Pigtail w/18AWG Zipcord (included)

Warranty: LED Module (5-Years)

Cable & Brass Parts (Lifetime*)





ORDERING INFORMATION

FIXTURE	COLOR TEMPERATURE	FINISH
NCHESC (NICHE ESCUTCHEON LIGHT)	2.7K (2700K)	VB (VINTAGE BRASS) 
	3K (3000K)	BR (BEADED BRASS) 

NCHESC — 2.7K — VB

e.g. **NCHESC2.7KVB** = 2700K, Vintage Brass Niche Escutcheon Light

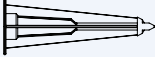
ACCESSORIES

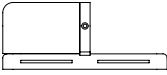
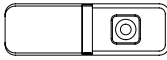
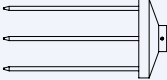
SKU	ITEM		
FM1/2xx FM3/4xx	1/2" / 3/4" Flush Mount		
		1/2" Flush Mount	3/4" Flush Mount
NCH.5-.75ADPT-VB	Niche Light 1/2" to 3/4" Adapter		
RTS8xx RTS12xx	8" / 12" Removable Tip Stakes		
		8" Stake	12" Stake
SMTxx	Solo Tree Mount		
SSTK1/2VB SSTK3/4VB	SpeedStakes™		

*Lifetime Warranty for certified installations. See terms and conditions of sale for details.