

NOSE LIGHT

The Nose Light offers a low profile way to add subtle lighting to a path, wall post or outdoor living area. Nose Lights are crafted of solid brass and utilize the patented Coastal Connector™ installation system. They are offered in five different finishes and accept a replaceable 3 watt LED lamp for the utmost in flexibility.

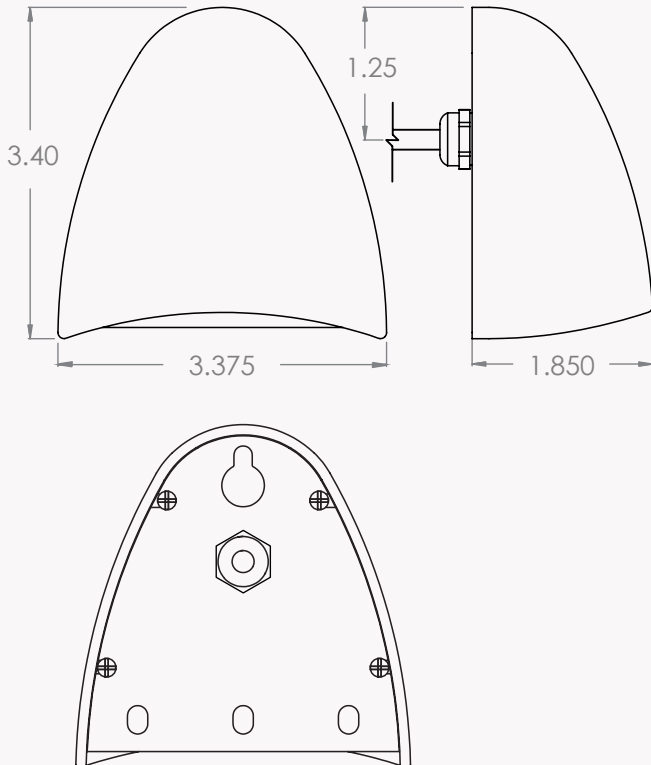

NOSE LIGHT SPECIFICATIONS

Size (H x W x D): 3.4in x 3.375in x 1.85in

Weight: 1.0 lb

Construction: Solid Brass

Finish: Vintage, Beaded, White, Nickel, Copper

Lamp: Replaceable LED Module, proprietary shaped MR11

Wattage: 2 Watts (140lm)

Color Temperature: 2700K, 3000K

Mounting: Surface Mount

Fixture Connector: CMC Male Direct Connector

Wiring: 5' CMC Cable





Warranty: 5-Year Limited Warranty*

LANDSCAPE LIGHTING AND OUTDOOR AUDIO
[ENGINEERED] **FOR LIFE**

258803
C SA US
CAT. NO.: NLxKVB
CSA C22.2 250.7-07
UL 1838



coastalsource.com

ORDERING INFORMATION

FIXTURE	COLOR TEMPERATURE	FINISH
NL (NOSE LIGHT)	2.7K (2700K)	VB (VINTAGE BRASS) 
	3K (3000K)	BR (BEADED BRASS) 
		WT (WHITE) 
		NI (NICKEL) 
		CU (COPPER) 

NL — 2.7K — VB e.g. **NL2.7KVB** = 2700K, Vintage Brass Nose Light

ACCESSORIES

SKU	ITEM	
NMPxx	Nose Light Mounting Plate	
LRFLTR-N	Light Reducing Filter	

*Lifetime Warranty for certified installations. See terms and conditions of sale for details.